

Success Stories



Indonesia CP fishery company



TECO

TECO (Vietnam) Electric & Machinery Co.,Ltd.

CÔNG TY TNHH ĐIỆN CƠ TECO VN

KCN Long Thành, Huyện Long Thành, Tỉnh Đồng Nai

T 061-3514108 ; 061-3514151 ~ 157

F 061-3514110

W www.teco.com.tw

MST 3600729671

Văn phòng đại diện:

T 08.36670650-08.38172418

F 08.36670651

300-302 Tên Lửa, P. Bình Trị Đông B, Q. Bình Tân, TP.HCM

高效率增氧机

HIGH EFFICIENCY AERATOR



JY-A101



JY-A102

参数表 Spec of

规格表 Specification	型号	Model	JY-A101	JY-A102
	马力	Horse Power	1	2
	电压	Voltage	380V / 415V	380V / 415V
	电相	Phase	3Φ 50Hz / 60Hz	3Φ 50Hz / 60Hz
	叶轮数	Impeller Account	2	4
	外形尺寸	Dimensions	177Cm x 163Cm x 89Cm	177Cm x 215Cm x 89Cm
性能 Capability	装运体积	Stowage Volume	0.6M ³	0.7M ³
	动力效力	Power	1.35Kg / Kwh	1.36Kg / Kwh
	增氧能力	Oxygen Supply Ability	1.26Kg / Hr	2.13Kg / Hr

功能特点：主要增加蟹，虾和鱼的存活率

效率：水流更强劲，溶氧速率更快

成本：更省电，使用年限更长，容易维修

溶氧：较高溶氧量

Function characteristic: Increase the survival rate of the crab, shrimp and fish mainly.

Efficiency: stronger water current, more perfect oxygen dissolving velocity.

Cost: saving electricity more, longer life-span, and easier maintenance.

Oxygen dissolving: higher Oxygen dissolving

增氧机零件组织图 SPARE PARTS OF PADDLE WHEEL AERATOR



高密度聚乙烯塑钢浮船
HDPE Floater



高质量马达
High Quality Motor



低阻抗减速机
Low Friction Efficient Reducer



一体成型叶轮
One Piece Blow Molding Impeller

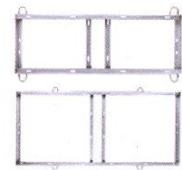

不锈钢机架
Stainless Steel Frame



蜗轮与蜗杆
Worm Wheel and Gear



三角支撑座
Pillow Bearing



活动接头
Movable joint



机盖
Motor Cover

定位杆
Setting Bar

不锈钢传动轴
Stainless Steel Transmission Shaft

射流式深水机

Description Air Injector Specification

射流式深水机部件:



JY-A202



单沟马达
Single-groove Motor



高密度聚乙烯塑钢浮船
HDPE Floater



轴承胶套
Bearing sleeve



不锈钢链接器
SS Movable Joint



不锈钢传动轴
SS Shaft



套筒
Sleeve



1HP 不锈钢叶轮
1HP SS Impeller



2HP 不锈钢叶轮
2HP SS Impeller



机盖
Motor Cover



叶轮风罩
Impeller Cover



深水式Y型固定器
Single-groove Motor

Character:

高效率增加氧气, 净化水质, 提供更好的水资源管理, 它适用于水深超过2米的养殖场和工业废水处理。少数部件, 易于装配和维修。

High oxygen supplement, purify water and provide better water management. It is suitable for water depth over 2M culture farm and industry waste water treatment. Few spare parts, easy assembly and maintenance.

Model	Phase	Voltage	HP	P	Impeller	Capacity of 20/40 Fee Container
JY-A202	3Φ	380V-415V	2HP	2P	1	100/200 Units

养虾全方位自动饲料机

All-round Automatic Feeder

中国专利号: 2011202396838

台湾专利号: M415565



JY-701

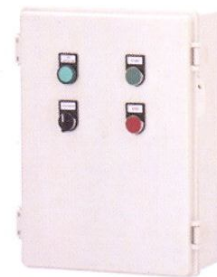
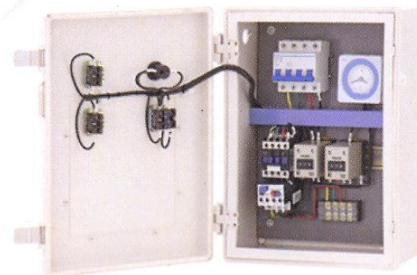

Control box

主要特点: 饲料机主要用于渔业使用, 适合用于虾(鱼)塘, 它提供高达150公斤的饲料空间, 附加一个一对一控制箱, 并且具有独特的出入口及360度洒料设计, 易于安装和操作。

Main feature: The automatic feeder is fit for fishery and is used in shrimp -breeding (fish as well). It provide a feed capacity of 150 kilograms It features by a one-for-one control box equipped with, an unique outlet design and all-around charging. It is easily to install and operate.

Model	HP	Phase	Voltage	Max Jetting Distance	Max Area Availability	Capacity	Weight	Dimensions (L x W x Hcm)
型号	马力	相数	电压	最远射程	最大面积	容量	重量	体积
JY-701	1	3Φ	380 / 415V	16meters	804m ²	150kgs	35.5kgs	66x66x150cm

海水养殖泵

mariculture pump

用途

- 渔业养殖, 农业灌溉, 低洼地区淹水排除。
- 景观瀑布用水。
- 水利工程。
- 其他用途之大水量供排水。

特点

- 电机采用干式结构, 内装有电机过载、过热保护; 两道机械密封, 防水佳;
- 过流部件采用导流壳式设计, 叶轮采用优秀水力模型, 低扬程大水量, 效率高;
- 电缆采用水密头式设计, 密封效果佳;
- 水下运行噪音小, 安装、维护方便。

Application

- Fishing, irrigation, flooding excluded at low-lying areas.
- Landscape Waterfall.
- Water-conservancy projects.
- other condition of high flow-rate.

Features

- Motor is dry structure, built-in heat protector in motor, can prevent the motor from burning out; Double mechanical seal, good waterproof effect;
- Diversion flow components using shell design, the optimal hydraulic model is used for impeller, applies to the condition of low lift head, high flow-rate, high efficiency;
- Cable head design with watertight, good sealing effect;
- Low noise with underwater operation, easy installation and maintenance;

性能规格表 Conversion table

型号 Type	电机 Motor					泵浦 Pump				重量 Weight kg	外型尺寸 Overall dimension mm			
	功率 Power		相数 Phase	极数 Pole	频率 Eff Hz	口径 Dia.		扬程 Head m	流量 Capacity m ³ /h		A	B	C	D
	kW	hp				mm	in							
MP53.7-150	3.7	5	3	4	50	150	6	3	160	102	690	286	773	960
MP55.5-200	5.5	7.5	3	4	50	200	8	4	250	150	770	358	895	1075
MP57.5-250	7.5	10	3	4	50	250	10	4	320	172	813	375	975	1115

外型尺寸图 Installation dimensions



海水养殖泵

mariculture pump

结构简图 Conversion

NO.	名称	Name	材质	
			JIS	Material
1	软管接头	Hose connector	HT200	FC200
2	导流外筒压盖	Diversion outer tube gland	HT200	FC200
3	电缆	Cables	-	-
4	马达盖	Motor cover	0Cr18Ni9	SUS304
5	上轴承座	Bearing bracket above	HT200	FC200
6	轴承	Bearing	-	-
7	马达本体	Motor cover	0Cr18Ni9	SUS304
8	定子	Stator	-	-
9	转子	Rotor	-	-
10	主轴	Shaft	3Cr13	SUS420J2
11	轴承压盖	Bearing cover	HT200	FC200
12	中承座	Bracket	0Cr18Ni9	SUS304
13	轴承	Bearing	-	-
14	机械密封	Mechanical seal	C/AL ₂ O ₃	C/AL ₂ O ₃
15	导叶体	Guide vane body	HT200	FC200
16	叶轮	Impeller	0Cr18Ni9	SUS304
17	泵体底盖	Bottom cover	HT200	FC200
18	滤底座	Strainer	HT200	FC200
19	O型圈	O-ring	-	NBR
20	O型圈	O-ring	-	NBR
21	O型圈	O-ring	-	NBR
22	O型圈	O-ring	-	NBR
23	密封环	Sealing-ring	-	LBC6

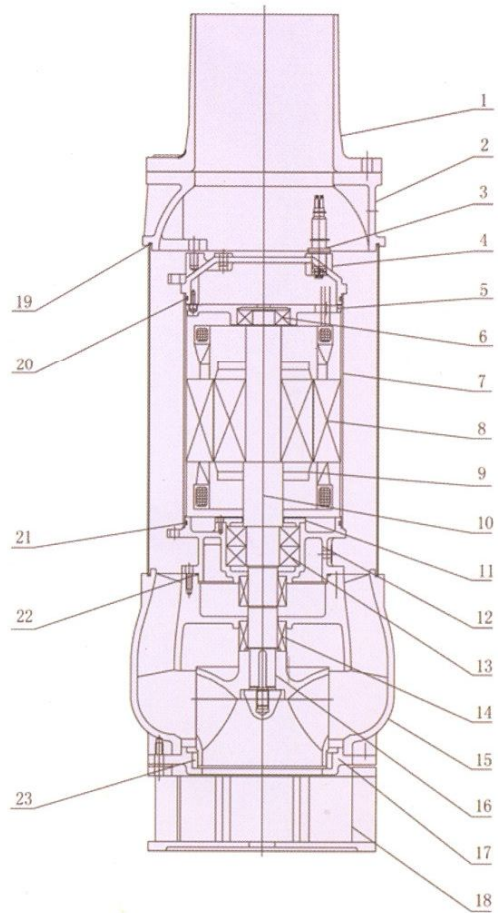

型谱图 Performance chart

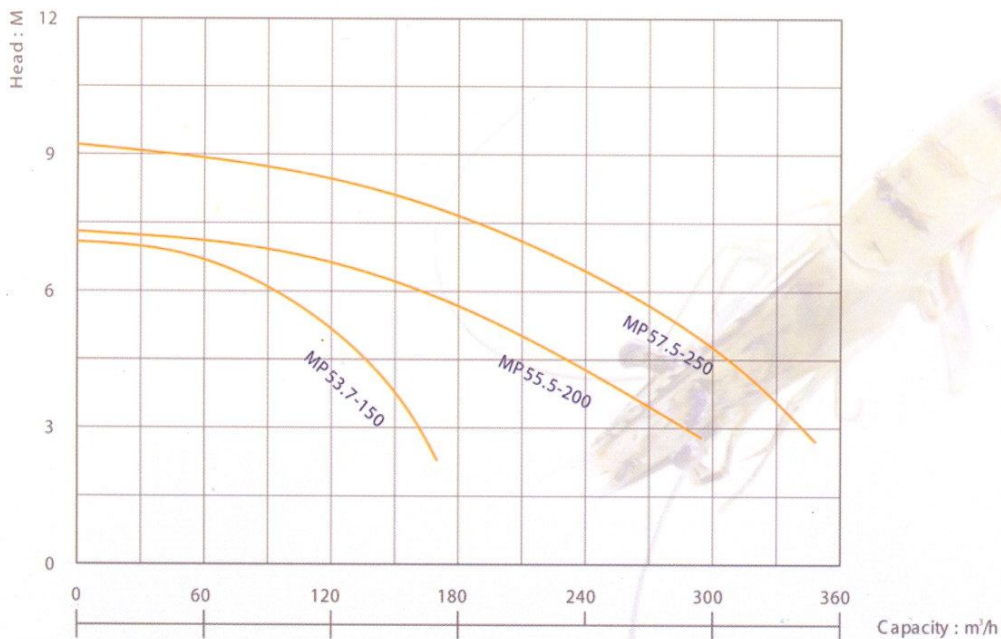

增氧机配件

Appurtenances of Aerctor



经济型连体马达减速机
One Piece Motor And Reducer



蜗轮与蜗杆
Worm Wheel and Gear



齿轮
Pinion

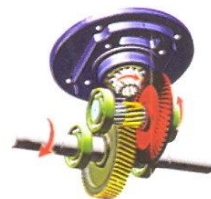

双齿轮减速机
Bevel Gear Reducer



三角支撑座
Pillow Bearing



不锈钢接器
SS Movable



活动接头
Movable joint



黑色小叶轮
Black Impeller

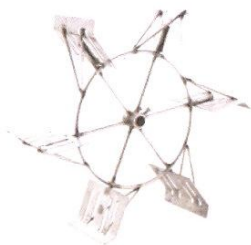

不锈钢叶轮
Stainless Steel Impeller



一体成型叶轮
One Piece Blow Molding Impeller



一体成型叶轮
One Piece Blow Molding Impeller



不锈钢双层架
SS Double Frame



不锈钢圆管双层机架
SS Tube Double Frame

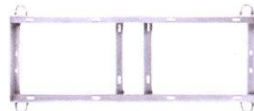

不锈钢机架
Stainless Steel Frame

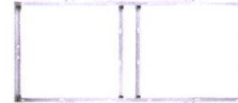

2HP 不锈钢机架
2HP Stainless Steel Frame

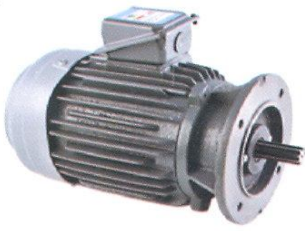

高质量马达
High Quality Motor



高质量马达
High Quality Motor



单沟马达
Single-groove Motor



经济型马达
Economic Motor



低阻抗减速机
Low Friction Efficient Reducer



84# 双齿轮减速机
84# Bevel Gear Reducer



76# 双齿轮减速机
76# Bevel Gear Reducer



控制箱
Control Box



PVC管
PVC Tube



高密度聚乙烯塑钢浮船
HDPE Floater



经济型盖
Economic Cover



不锈钢传动轴
Stainless Steel Transmission Shaft



定位杆
Setting Bar



2HP 不锈钢叶轮
2HP SS Impeller

TECO